

Fluid Cooling Industrial AOVH Series

Performance Notes

- High performance AO
- High flow rates
- Adjustable louvers (manual)
- Compact
- One or two pass



OPTIONS

Internal SAE straight threads
SAE & metric connections
Internal pressure bypass
Corrosive resistant marine coating

Ratings

Maximum Operating Pressure
300 PSI

Maximum Operating Temperature
400°F

Materials

Tubes Copper

Fins Aluminum

Turbulators Steel

Fan Blade Aluminum with steel hub

Fan Guard Zinc plated steel

Cabinet Steel with powder coat finish

Manifolds Steel

Connections Steel

Two Pass (Low to Medium Oil Flows)

Model	Flow GPM (USA)
AOVHR-5-2	4-50
AOVHR-10-2	4-60
AOVHR-15-2	4-60
AOVHR-20-2	4-80
AOVHR-25-2	4-80
AOVHR-30-2	4-80
AOVHR-35-2	6-80
AOVHR-40-2	8-80

AOVHR Series with Bypass

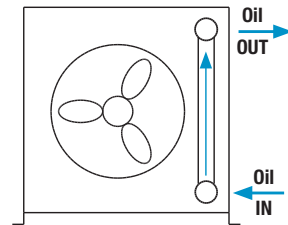

How to Order

[]	-	[] []	-	[]	-	[]	-	[]	-	[]
Model Series AOVH AOVHR - Internal pressure bypass included		Model Size Selected		Number of Passes* Blank - No Bypass 2 - Two Pass Only		Connection Type Blank - NPT S - SAE M - Metric		Bypass Setting* Blank - No Bypass 30 - 30 PSI 60 - 60 PSI		Specify Motor Required Single Phase Single Phase Expl. Proof Three Phase Three Phase 575 Volt Three Phase Expl. Proof

***ADD FOR AOVHR MODELS ONLY:** Bypass setting & number of passes. Only available in Two Pass. This is a partial flow pressure bypass only. It is not designed to be a full flow system bypass.

Dimensions

Model	A	B	C	D	E	F	G	K	L	M		N	P	Q	Net Weight (LBS)
										NPT Male	SAE Female				
AOVH-5	7.40	14.81	5.90	11.81	19.93	9.19	8.31	3.84	7.69	1½"	#24 SAE	5.84	11.69	16.81	67
AOVH-10	9.50	19.00	6.56	13.12	19.49	10.50	12.50	4.44	8.88	1½"	1½-12UN Thread	7.94	15.88	21.00	78
AOVH-15	10.19	20.38	7.87	15.75	19.49	13.12	13.88	5.75	11.50	1½"		8.62	17.25	22.38	90
AOVH-20	11.91	23.81	9.19	18.38	19.49	15.75	17.19	7.00	14.00	2"		10.28	20.56	25.81	110
AOVH-25	13.34	26.68	11.81	23.62	23.58	21.00	20.19	9.62	19.25	2"	#32 SAE 2½-12UN Thread	11.78	23.56	28.68	157
AOVH-30	15.81	31.62	13.78	27.56	23.33	24.94	25.12	11.59	23.19	2"		14.25	28.50	33.62	190
AOVH-35	16.90	33.81	15.09	30.19	23.06	27.56	27.31	12.90	25.81	2"		15.34	30.69	35.81	315
AOVH-40	20.18	41.62	18.37	36.75	23.06	34.12	35.12	16.19	32.38	2"		19.25	38.50	43.62	350

NOTE: All dimensions in inches.

Fan Rotation Clockwise/Facing Motor Shaft

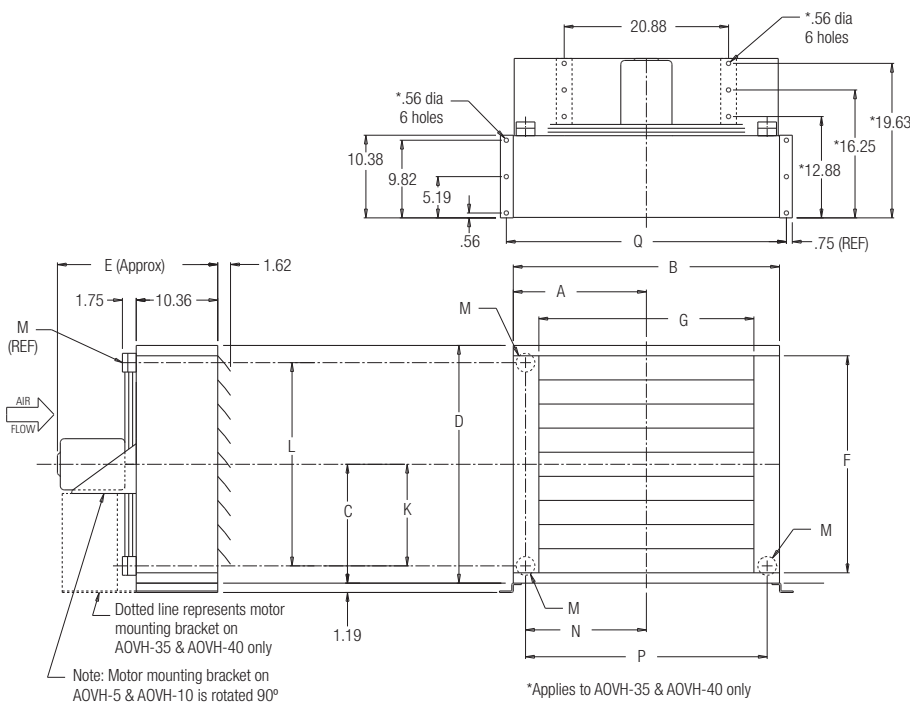

Piping Diagram Without Bypass

One Pass

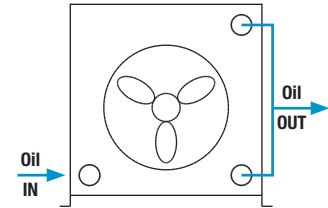

Two Pass

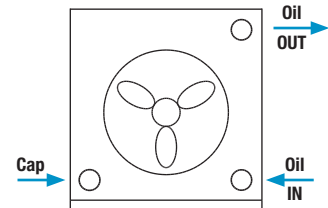

*See dimension chart for NPT or optional internal SAE connection size.

Lubrication Notes

Caution: Do not over oil or over grease. **Ball bearings** – No grease needed at start up. Grease as follows:

5,000 Hours/Year	5 Year Grease Interval
Continuous — Normal Applications	2 Years
Seasonal Service — Motor is idle for 6 months or more	1 Year
Continuous — High ambients, dirty or moist locations, high vibration	6 Months

Performance Curves

One Pass Oil (AOVH)

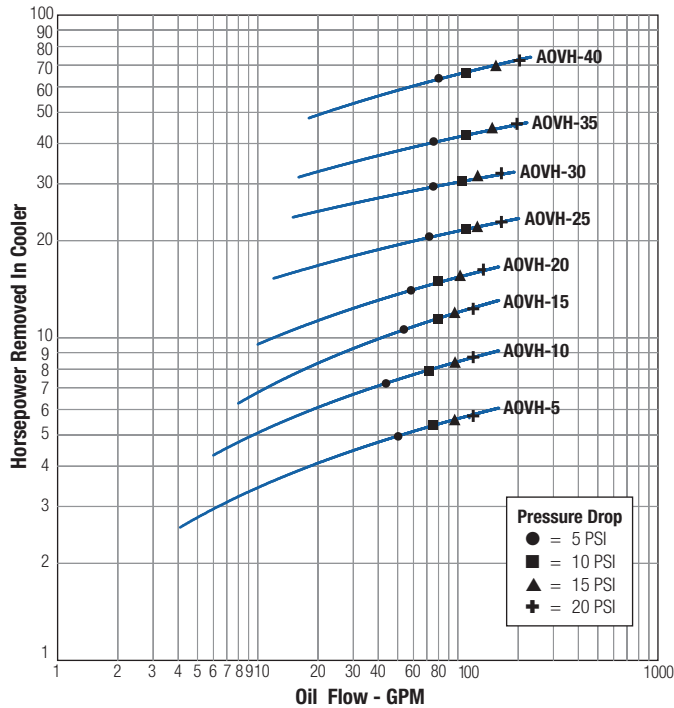

Two Pass Oil (AOVH or AOVHR)

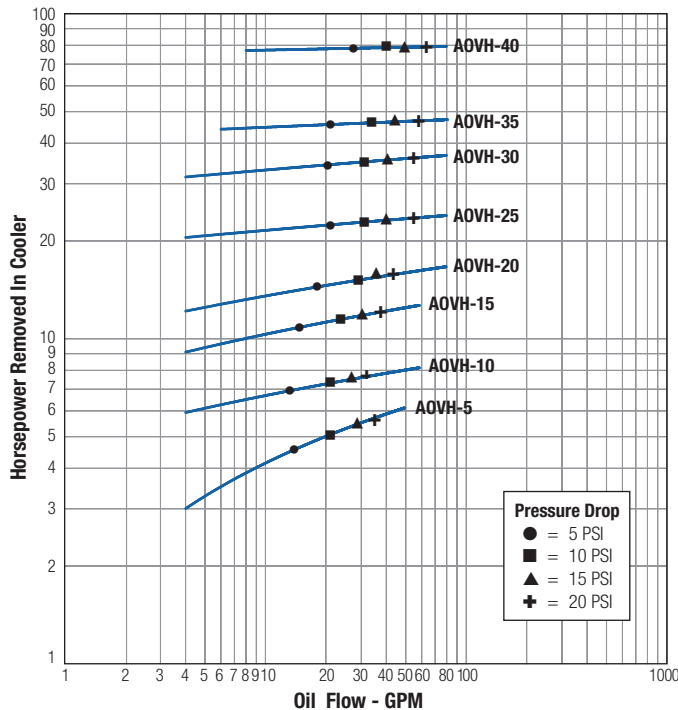

Selection Procedure

Performance Curves are based on 50SSU oil leaving the cooler 40°F higher than the ambient air temperature used for cooling. This is also referred to as a 40°F approach temperature.

STEP 1 Determine the Heat Load. This will vary with different systems, but typically coolers are sized to remove 25 to 50% of the input nameplate horsepower.
 (Example: 100 HP Power Unit x .33 = 33 HP Heat load.)
 If BTU/HR is known: $HP = \frac{BTU/HR}{2545}$

STEP 1 Determine Approach Temperature. Desired oil leaving cooler °F – Ambient air temp. °F = Actual Approach

STEP 1 Determine Curve Horsepower Heat Load. Enter the information from above:
 $Horsepower\ heat\ load \times \frac{40 \times Cv}{Actual\ Approach} = Curve\ Horsepower$

STEP 1 Enter curves at oil flow through cooler and curve horsepower. Any curve above the intersecting point will work.

STEP 1 Determine Oil Pressure Drop from Curves:
 ● = 5 PSI ■ = 10 PSI ▲ = 15 PSI + = 20 PSI
 Multiply pressure drop from curve by correction factor found in oil ΔP correction curve.

Desired Reservoir Temperature

Return Line Cooling: Desired temperature is the oil temperature leaving the cooler. This will be the same temperature that will be found in the reservoir.

Off-Line Recirculation Cooling Loop: Desired temperature is the oil temperature entering the cooler. In this case, the oil temperature change must be determined so that the actual oil leaving temperature can be found.

Calculate the oil temperature change (oil ΔT) with this formula:
 $Oil\ \Delta T = (BTU's/HR) / (GPM\ Oil\ Flow \times 210)$

To calculate the oil leaving temperature from the cooler, use this formula:
 $Oil\ Leaving\ Temp. = Oil\ Entering\ Temp - Oil\ \Delta T$

This formula may also be used in any application where the only temperature available is the entering oil temperature.

Oil Pressure Drop: Most systems can tolerate a pressure drop through the heat exchanger of 20 to 30 PSI. Excessive pressure drop should be avoided. Care should be taken to limit pressure drop to 5 PSI or less for case drain applications where high back pressure may damage the pump shaft seals.

Oil Pressure Correction

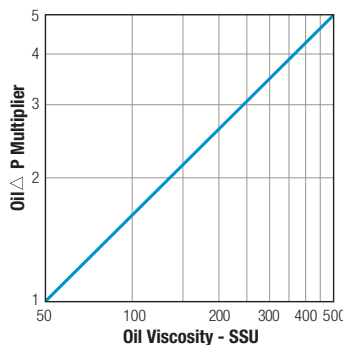

Oil Temperature

Typical operating temperature ranges are:

Hydraulic Motor Oil	110° - 130°F
Hydrostatic Drive Oil	130° - 180°F
Bearing Lube Oil	120° - 160°F
Lube Oil Circuits	110° - 130°F

Specifications

Electric motor & Fan data*

Model	CFM	Sound dB(A)* at 7 FT	HP	Volts	Phase	Full Load Amps	HZ	Nema Frame	RPM	Type	Circuit	Thermal Overload	Bearing B-Ball
AOVH-5	780	85	1/2	115/208-230	1	7.4/3.9-3.7	60	48	3450	TEFC	C	No	B
	780	85	1/2	208-230/460	3	2.1-2/1.	60	48	3450	TEFC	D	No	B
AOVH-10	1110	85	1/2	115/208-230	1	7.4/3.9-3.7	60	48	3450	TEFC	A	No	B
	1110	85	1/2	208-230/460	3	2.1-2/1.	60	48	3450	TEFC	D	No	B
AOVH-15	1590	91	1/2	115/208-230	1	7.4/3.9-3.7	60	48	3450	TEFC	A	No	B
	1590	91	1/2	208-230/460	3	2.1-2/1.	60	48	3450	TEFC	D	No	B
AOVH-20	2168	91	1/2	115/208-230	1	7.4/3.9-3.7	60	48	3450	TEFC	C	No	B
	2168	91	1/2	208-230/460	3	2.1-2/1.	60	48	3450	TEFC	D	No	B
AOVH-25	3000	81	1	115/208-230	1	12.4/6.5-6.2	60	56	1725	TEFC	C	No	B
	3000	81	1	208-230/460	3	3.6-3.4/1.7	60	56	1725	TEFC	D	No	B
AOVH-30	4095	84	1	115/208-230	1	12.4/6.5-6.2	60	56	1725	TEFC	C	No	B
	4095	84	1	208-230/460	3	3.6-3.4/1.7	60	56	1725	TEFC	D	No	B
AOVH-35	Not Available				1	9.-8.6/4.3	60	182T	1725	TEFC	D	No	B
	5921	89	3	208-230/460	3	9.-8.6/4.3	60	182T	1725	TEFC	D	No	B
AOVH-40	Not Available				1	9.-8.6/4.3	60	182T	1725	TEFC	D	No	B
	9609	91	3	208-230/460	3	9.-8.6/4.3	60	182T	1725	TEFC	D	No	B

*Published electrical ratings are approximate, and may vary because of motor brand. Actual ratings are on motor nameplate.

**Catalog dB(A) sound levels are at seven (7) feet. dB(A) sound levels increase by six (6) dB(A) for halving this distance and decrease by six (6) dB(A) for doubling this distance.

Explosion Proof Motors (Class I GP.D & Class II GP.F, G)*

Model	CFM	Sound dB(A)* at 7 FT	HP	Volts	Phase	Full Load Amps	HZ	Nema Frame	RPM	Type	Circuit	Thermal Overload	Bearing B-Ball
AOVH-5	780	85	1/2	115/230	1	7.4/3.7	60	48	3450	FC	C	Yes	B
	780	85	1/2	208-230/460	3	2.4-2.2/1.1	60	48	3450	FC	D	Yes	B
AOVH-10	1110	85	1/2	115/230	1	7.4/3.7	60	48	3450	FC	C	Yes	B
	1110	85	1/2	208-230/460	3	2.4-2.2/1.1	60	48	3450	FC	D	Yes	B
AOVH-15	1590	91	1/2	115/230	1	7.4/3.7	60	48	3450	FC	C	Yes	B
	1590	91	1/2	208-230/460	3	2.4-2.2/1.1	60	48	3450	FC	D	Yes	B
AOVH-20	2168	91	1/2	115/230	1	7.4/3.7	60	48	3450	FC	C	Yes	B
	2168	91	1/2	208-230/460	3	2.4-2.2/1.1	60	48	3450	FC	D	Yes	B
AOVH-25	3000	81	1	115/230	1 ▲	12.4/6.2	60	56	1725	FC	C	Yes	B
	3000	81	1	230/460	3	3.4/1.7	60	56	1725	FC	D	No	B
AOVH-30	4095	84	1	115/230	1 ▲	12.4/6.2	60	56	1725	FC	C	Yes	B
	4095	84	1	230/460	3	3.4/1.7	60	56	1725	FC	D	No	B
AOVH-35	Not Available				1	8.6/4.3	60	182T	1725	FC	D	No	B
	5921	89	3	230/460	3	8.6/4.3	60	182T	1725	FC	D	No	B
AOVH-40	Not Available				1	8.6/4.3	60	182T	1725	FC	D	No	B
	9609	91	3	230/460	3	8.6/4.3	60	182T	1725	FC	D	No	B

*Published electrical ratings are approximate, and may vary because of motor brand. Actual ratings are on motor nameplate.

▲ = CL. 1, GP. D only TEFC = Totally enclosed, fan cooled FC = Fan cooled C = Capacitor start - Induction run D = Squirrel cage

C_v Viscosity Correction

Average Oil Temp °F	OIL					
	SAE 5 110 SSU at 100°F 40 SSU at 210°F	SAE 10 150 SSU at 100°F 43 SSU at 210°F	SAE 20 275 SSU at 100°F 50 SSU at 210°F	SAE 30 500 SSU at 100°F 65 SSU at 210°F	SAE 40 750 SSU at 100°F 75 SSU at 210°F	50-50 Ethylene Glycol & Water
100	1.14	1.22	1.35	1.58	1.77	1.11
150	1.01	1.05	1.11	1.21	1.31	1.02
200	.99	1.00	1.01	1.08	1.10	.96
250	.95	.98	.99	1.00	1.00	.95